



Vectran[®]

Grasp The World Of Tomorrow

ENGINEERING DATA



TABLE OF CONTENTS

| | |
|----------|-------------------------------------|
| Page 1: | Introduction |
| Page 2: | Vectra Polymer |
| Page 3: | Tensile Properties |
| Page 4: | Thermal Properties |
| Page 6: | Chemical Resistance |
| Page 10: | Creep |
| Page 11: | Abrasion Resistance |
| Page 14: | Compression/Flex Fatigue |
| Page 16: | Pin Diameter |
| Page 17: | Vibration Damping/Impact Resistance |
| Page 19: | Cut Resistance |
| Page 19: | Twist |
| Page 21: | UV Resistance |

Vectran® is a high-performance liquid crystal polymer (LCP) fiber offering a balance of properties unmatched by other performance fibers. Some of these unique properties were discovered through 20 years of research and development of the polymer Vectra®. Celanese committed to developing a thermotropic (melt processable) LCP in the mid 1970's and commercialized the Vectra family of resins in 1985.



The molecules of the liquid crystal polymer are rigid and position themselves into randomly oriented domains. The polymer exhibits anisotropic behavior in the melt state, thus the term "liquid crystal polymer." Upon extrusion of the molten polymer through small spinnerette holes, the molecular domains align parallel to each other along the fiber axis. The highly oriented fiber structure results in high tensile properties. A schematic diagram of the molecular chain structure is shown in Figure 1.

Figure 1: Schematic Of Molecular Chain Structure Of Fiber

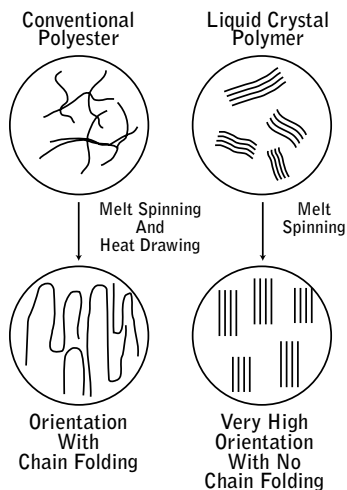

The attributes of Vectra, such as excellent mechanical properties, property retention over a wide range of temperatures, excellent chemical resistance, and low moisture pick-up, carry over to the fiber. The fiber also exhibits no measurable creep when loaded up to 50% of the threadline breaking load. It has excellent abrasion resistance with appropriate finishes applied to the fiber.

Chemical Resistance

Chemical Resistance:

Vectra LCP is virtually unaffected by most acids, bases, and solvents over a broad temperature range.

Low Permeability

Low Permeability:

Vectra LCP exhibits barrier properties superior to any other melt-processible polymeric barrier material. Figure 2 compares the permeability of various traditional barrier films to oxygen and water vapor. Permeation of various gases through Vectra LCP is not affected by humidity to any significant degree. Other gases for which LCPs exhibit above-average barrier performance include carbon dioxide, nitrogen, argon, hydrogen, and helium.

Dimensional Stability

Dimensional Stability:

Vectra LCPs have a coefficient of thermal expansion (CTE) close to that of glass (Figure 3). Other high-performance polymers typically fall in a range of 20 to 60 ppm/°C. Vectra LCPs can perform from cryogenic temperatures to over 200°C with little dimensional change.

Radiation Resistance

Radiation Resistance:

Vectra LCPs are transparent to microwave energy and are virtually unaffected by exposure to 500 megarads of cobalt 60.

Figure 2: Permeability of Polymer Films.

The Vectra A900 data for 1 mil film

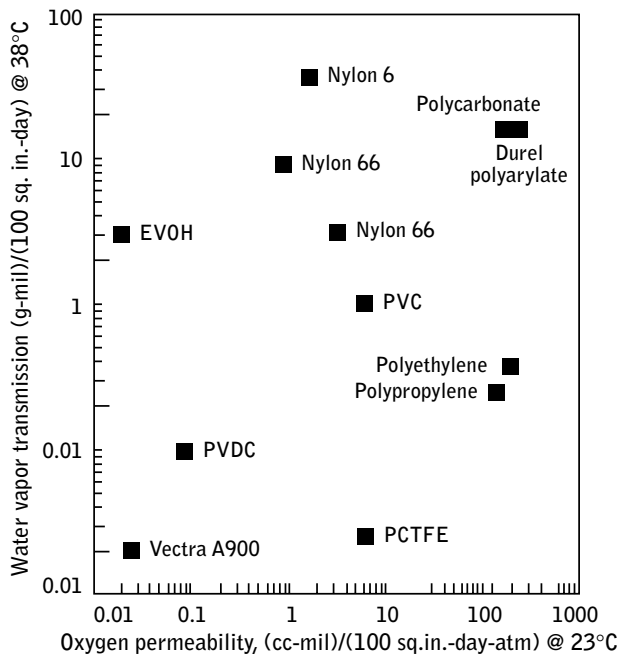
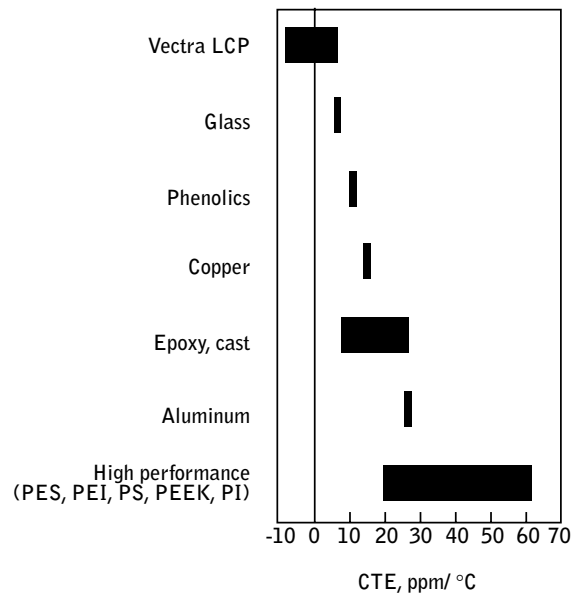
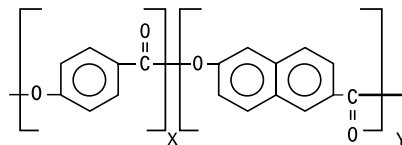

Figure 3: Coefficients of Thermal Expansion (CTE)



Vectran fiber is a polyester-polyarylate fiber. The differences between Vectran fiber and two other high-performance fibers, aramid and ultra-high molecular weight polyethylene (UHMWPE) are as follows: Vectran fiber is thermotropic, it is melt-spun, and it melts at a high temperature. Aramid fiber is lyotropic, it is solvent-spun, and it does not melt at high temperature. UHMWPE fiber is gel-spun, and it melts at a low temperature. The formula for the Vectran molecule is shown below (Figure 4).

Figure 4: Vectran Molecular Structure



In conventional polyesters, the molecular chains are random and flexible. The fiber must be further oriented, generally through a combination of extrusion speed and post-spin drawing, to obtain higher tensile properties.

Tensile Properties

Tensile Properties:

Vectran HS has tensile properties similar to the aramids. Table 1 compares the tensile properties of various reinforcing materials. Table 2 lists mechanical properties of Vectran. The tensile strength of Vectran fiber is conservatively listed as 23 grams per denier for 1500 denier yarn. Lower deniers have higher tensile strengths.

Table 1:
Comparison of Properties of Various Engineering Materials

| Material | Density g/cm ³ | Tensile Strength Msi | Specific Tensile Strength Ksi/g/cm ² | Tensile Modulus Msi | Specific Modulus Msi/g/cm ² |
|--------------|------------------------------|----------------------------|---|---------------------------|--|
| Vectran® | 1.4 | 412 | 294 | 9.4 | 6.7 |
| Steel | 7.8 | 145 | 19 | 29 | 3.5 |
| Titanium | 4.5 | 134 | 30 | 16 | 3.5 |
| Aluminum | 2.8 | 67 | 24 | 10 | 3.5 |
| Glass Fiber | 2.5 | 246 | 98 | 10 | 4.0 |
| Carbon Fiber | 1.9 | 228 | 120 | 55 | 29.0 |
| Boron Fiber | 2.6 | 443 | 170 | 23 | 9.0 |
| SiC Fiber | 3.5 | 500 | 143 | 57 | 16.0 |

Table 2:
Mechanical Properties of Vectran HS 1500 denier/300 filament Yarn

| | |
|---|-----------------|
| Tensile Strength at break* Mpa/g/denier | 2850 / 23+ |
| Initial Tensile Modulus* Gpa/Msi/g/denier | 65 / 9.4 / 525+ |
| Elongation at break* % | 3.3 |

* ASTM D885 with 10% strain rate; 25 cm gauge length; 2.5 twists/in.

Thermal Properties

Thermal Properties:

Vectran HS exhibits interesting thermal properties. Compared to other fibers, Vectran thermal performance is as follows:

- Good LOI (equivalent to aramids)
- Low thermal shrinkage (hot air, boiling water and laundry)
- No melting or dripping in vertical flammability tests or 500°F hot air
- Good Thermal Protective Performance (TPP) which is a measure of a material's ability to protect the wearer from second-degree skin burn
- Good strength retention after hot air and radiant energy exposures
- Low smoke generation
- Low, negative coefficient of thermal expansion
- Excellent property retention in a broad temperature range

Table 3 compares thermal properties for various fibers:

Table 3:

Fiber Thermal Properties

| | Vectran | Aramid |
|-------------------------------|---------|--------------|
| LOI | >30 | 30 |
| M.P., °C | 330 | None (Chars) |
| HAS (Hot air shrink 500°F), % | <0.5 | 8.1 |
| BWS (Boiling water shrink), % | <0.5 | 5.1 |
| Moisture Regain, % | <0.1 | 3.7 |
| TGA 50% | 550 | 560 |

(Thermogravimetric Analysis @ 50% wt. Loss), °C

Vectran was exposed to a temperature range of 25-250°C for 24 hours and returned to ambient temperature. Tensile properties were then measured (Fig. 5). The strength retention of Vectran after exposure to this temperature range was superior to aramid fiber.

Figure 5: Strength After Thermal Exposure

Retention Of Fiber Strength After 24 Hour Exposure To Temperature

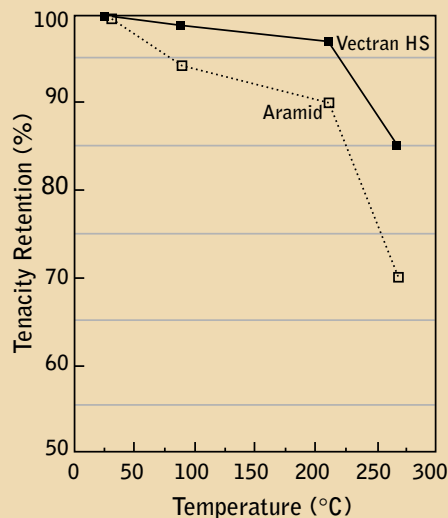

Vectran samples were cycled from ambient temperature to 120°C for eight hours, returned to ambient temperature, and tested. No reduction in Vectran strength was observed after 30 cycles (Fig. 6). Similar results were observed at 195°C (Fig. 7). Again, Vectran retained tensile strength after exposure and was superior to aramid fiber.

Figure 6: Vectran HS Tenacity vs Cycles At Temperature

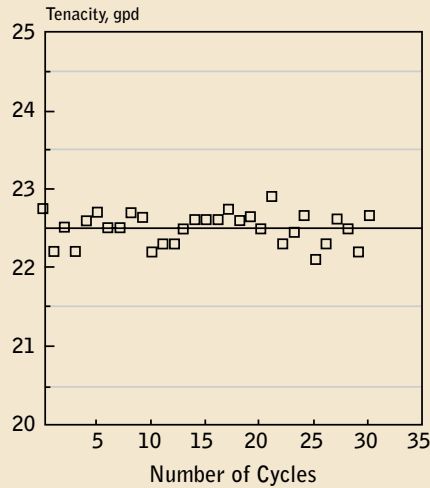

Each Cycle = 8 hours @ 120°C followed by cool-down to ambient temperature

Figure 7: Celanese 1500/300 Vectran HS Tenacity – Cycles at 195°C

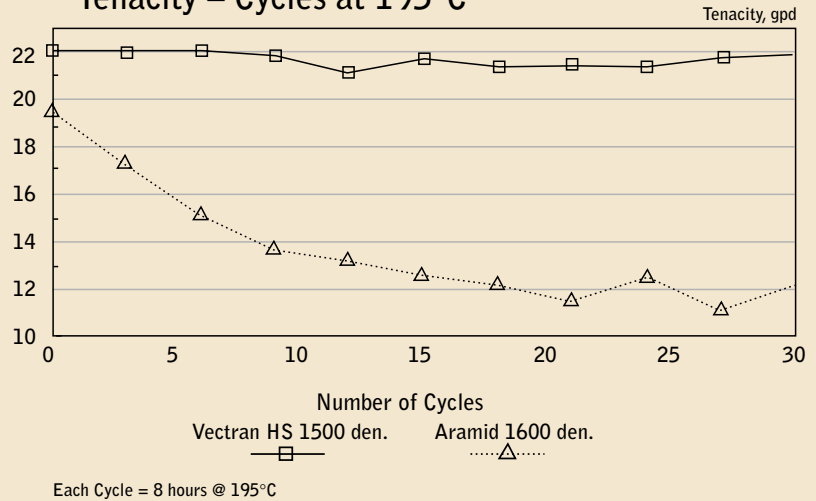

Each Cycle = 8 hours @ 195°C

Vectran did not retain its strength as well as aramids when tested at high temperature (Fig. 8). This is consistent with the thermoplasticity of Vectran.

Figure 9 displays the relationship between Vectran physical properties and temperature over time.

Figure 8: Strength At High Temperatures

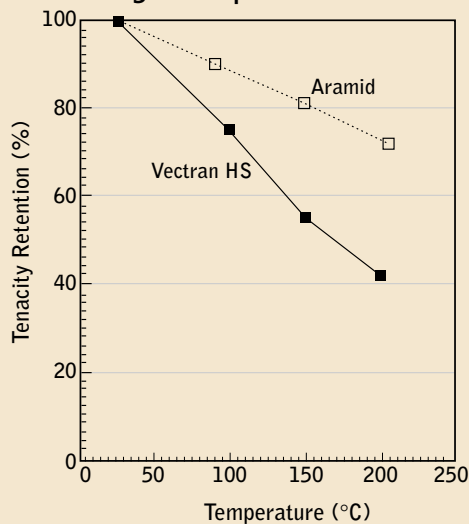
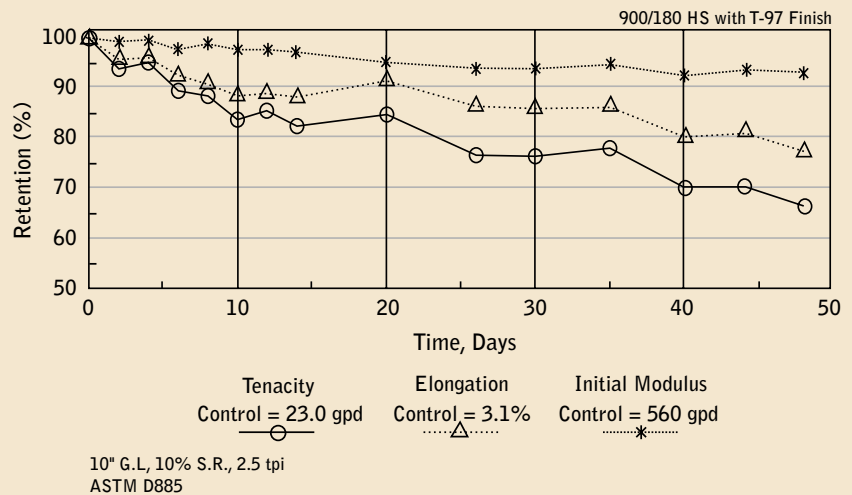

Figure 9: Celanese Vectran Fiber Physical Property Retention vs Time @ 195°C



10" G.L., 10% S.R., 2.5 tpi
ASTM D885

Vectran Fiber

Vectra resin retains its properties very well at extremely low temperatures (Table 4). It is expected that the fiber with much higher tensile strength and modulus will behave similarly to the resin at the same low temperatures.

Table 4:
Low Temperature Properties of Vectra Resin

| Temperature °F | Tensile Strength (psi) | Tensile Modulus (psi) | Impact, Notched Izod (ft-lb/in) |
|----------------|------------------------|-----------------------|---------------------------------|
| 73 | 23,000 | 1.5 X 10 ⁶ | 13.0 |
| 73 | 23,000 | 1.5 X 10 ⁶ | 13.0 |
| 32 | 26,000 | 1.6 X 10 ⁶ | 12.0 |
| -220 | 24,000 | 2.1 X 10 ⁶ | 10.5 |
| -320 (LN2) | 24,000 | 2.1 X 10 ⁶ | 9.5 |

Vectran has a low, negative coefficient of thermal expansion (Table 5). This is particularly beneficial for dimensional control of composites.

Table 5:
Vectran HS CTE at Various Temperatures

| Temperature Range | CTE (m/m - °C X 10 ⁻⁶) (in/in - °F X 10 ⁻⁶) |
|----------------------------|---|
| 20-145°C or, 68-293°F | -4.8 -2.7 |
| 145-200°C or, 293-392°F | -14.6 -8.1 |
| 200-290°C or, 392-554°F | -26.7 -14.8 |

Chemical Resistance

Chemical Resistance:

Table 6 lists the chemical resistance of Vectra® A950 Resin from which Vectran® Fiber is produced. In most cases, exposure to aggressive chemicals yields no appreciable change in properties, dimensions, or weight over time. Vectra resin is hydrolytically stable, resistant to organic solvents, and stable to some acids of <90% concentration. It is also resistant to bases of <30% concentration, and it retains its chemical resistance at elevated temperatures.

The chemical resistance of Vectra A950 Resin from which Vectran Fiber is produced is listed. This data should be used as a guide only. The data indicate the test conditions and resulting ratings. These conditions represent limits of test apparatus and not necessarily limits of use. It is strongly recommended that the end user test any material in the actual chemical environment of product stream before use to determine its suitability. Changes in concentration, temperature, mixtures, or contaminants can significantly affect results. All chemical resistance data are based on average of five molded ASTM flexural test bars (5.0" X 0.5" X 0.125").

Advanced Materials Group (AMG) Rating

- A. Essentially no effect: Less than 5% change in mechanical properties and less than 2% change in weight and dimensions.
- B. Some change.
- C. Not recommended

MPE Rating System as suggested by Modern Plastics Encyclopedia 1986-87 page 422.

- A. No significant effect: <0.5%, <0.2%, <10% change in weight, dimension, and strength, respectively; slight decoloration.
- B. Significant, but usually not conclusive: 0.5%-1.0%, 0.2%-0.5%, 10%-20% change in weight, dimension and strength respectively; discolored.
- C. Usually significant: >1.0%, >0.5%, >20% change in weight, dimension and strength respectively; distorted, warped, softened or crazed.

Table 6:
Chemical Resistance of Vectra A950 Resin:

| Reagent | Concentration % | Time, Days | Temperature | | Rating | |
|--|-----------------|------------|-------------|-----|--------|-----|
| | | | °F | °C | AMG | MPE |
| Acetic Acid (glacial) | 100 | 30 | 245 | 118 | A | - |
| Acetone | 100 | 180 | 133 | 56 | A | - |
| Antifreeze/Water | 50 | 30 | 122 | 50 | A | - |
| | 50 | 30 | 250 | 121 | B | - |
| Brake Fluid: Castrol® TLX 988C | 100 | 30 | 250 | 121 | A | - |
| Chlorine Gas (dry) | 100 | 60 | 73 | 23 | A | A |
| Chlorine/Water (saturated solution) | - | 60 | 73 | 23 | A | A |
| Chromic Acid | 50 | 30 | 158 | 70 | A | A |
| | 50 | 60 | 158 | 70 | A | A |
| | 70 | 30 | 190 | 88 | A | B |
| Dimethyl Formamide | 100 | 60 | 150 | 66 | A | A |
| Diphenylamine | 100 | 180 | 150 | 66 | A | A |
| Diphenylcarbonate | 100 | 10 | 482 | 250 | C | - |
| Ethanol | 100 | 30 | 125 | 52 | A | - |
| Ethyl Acetate | 100 | 180 | 171 | 77 | A | - |
| Ethylene Diamine | 50 | 90 | 73 | 23 | A | A |
| | 50 | 180 | 73 | 23 | A | A |
| | 100 | 30 | 212 | 100 | C | - |
| Fluorinert® (FC-70) | 100 | 1 | 419 | 215 | A | - |
| Formic Acid | 80 | 30 | 216 | 104 | A | - |
| | 80 | 270 | 216 | 104 | B | - |
| | 80 | 455 | 216 | 104 | C | - |
| Freon® (R-12, R-22) Dichlorodifluoromethane, Chlorodifluoromethane | 100 | 30 | 175 | 80 | A | - |
| Freon® 113 (@ Reflux) | 100 | 60 | 117 | 47 | A | A |
| Fuel C, ASTM D471 | 100 | 30 | 250 | 121 | A | - |

Chemical Resistance

Table 6 (cont'd):

| Reagent | Concentration % | Time, Days | Temperature | | Rating | |
|--|-----------------|-------------|-------------|-----|--------|-----|
| | | | °F | °C | AMG | MPE |
| (50/50 Iso-octane/Toluene) | | | | | | |
| Hexafluoroisopropanol | - | 10 | 73 | 23 | C | - |
| Hydrochloric Acid | 37 | 30 | 190 | 88 | A | C |
| | 37 | 60, 90, 120 | 190 | 88 | B | C |
| Hydrochloric Acid (anhydrous) | 100 | 30, 180 | 73 | 23 | C | - |
| Methanol @ Reflux | 100 | 30 | 148 | 64 | A | - |
| Methylene Chloride | 100 | 180 | 104 | 40 | A | - |
| Monochloroacetic Acid | 100 | 180 | 122 | 50 | A | - |
| Nitric Acid | 50 | 30 | 158 | 70 | A | A |
| | 50 | 60 | 158 | 70 | A | A |
| | 70 | 30 | 190 | 88 | B | C |
| Nitrobenzene | 100 | 30 | 150 | 66 | A | - |
| Nitroglycerin | 100 | 30 | 150 | 66 | A | - |
| Oil, Motor Oil 10-30W | 100 | 30 | 250 | 121 | A | - |
| Oil, Silicone | 100 | 30 | 392 | 200 | A | - |
| Pentafluorophenol | 100 | 10 | 140 | 60 | C | - |
| Phenol | 100 | 180 | 212 | 100 | A | - |
| Skydrol® | 100 | 30 | 160 | 71 | A | - |
| Sodium Hydroxide | 5 | 30 | 73 | 23 | A | A |
| | 5 | 90 | 73 | 23 | A | A |
| | 5 | 7 | 158 | 70 | A | A |
| | 5 | 30 | 158 | 170 | A | B |
| | 5 | 60 | 158 | 70 | B | C |
| | 10 | 30 | 73 | 23 | A | A |
| | 10 | 90 | 73 | 23 | A | A |
| | 10 | 30 | 190 | 88 | B | - |
| | 30 | 30 | 190 | 88 | C | - |
| Sour Gas | 100 | 30 | 250 | 121 | A | - |
| 70/30 Heptane Toluene, Copper ion, t-Butyl Hydroperoxide | | | | | | |
| Sulfuric Acid | 50 | 60 | 190 | 88 | A | A |
| | 70 | 5 | 375 | 190 | C | - |
| | 93 | 8 | 73 | 23 | B | - |
| | 93 | 30 | 250 | 121 | C | - |
| Toluene | 100 | 180 | 232 | 111 | A | - |
| Trichloroethane | 100 | 90 | 150 | 66 | A | - |
| Unleaded Gasolene | 100 | 30 | 250 | 121 | A | - |
| Unleaded Gasolene w/ 10% Methanol | 90 | 30 | 250 | 121 | B | - |
| Urea | 46 | 60 | 190 | 88 | B | - |
| Water, Liquid | 100 | 10 | 250 | 121 | A | - |
| Water, Steam | - | 60 | 250 | 121 | B | - |

Table 7 shows the strength retention of Vectran HS fiber after exposure to selected chemicals.

Table 7:
Vectran HS Fiber Strength Retention After Chemical Exposure

| Chemical | Concentration % | Temperature °C | Time Days | Strength Retention % |
|-------------------|-----------------|----------------|-----------|----------------------|
| Acetone | 100 | 20 | 1 | 95 |
| Nitric Acid | 70 | 20 | 1 | 76 |
| Hydrochloric Acid | PH=1 | 20 | 1 | 99 |
| | | 70 | 7 | 95 |
| Perchloroethylene | 100 | 20 | 1 | 92 |
| Sodium Hydroxide | PH=13 | 20 | 1 | 100 |
| | | 70 | 7 | 91 |
| Sulfuric Acid | 10 | 20 | 1 | 93 |

Aramid fibers have poor resistance to bleach and UHMWPE fibers are sensitive to high temperatures associated with drying. Therefore the cost and performance of safety wear improves when garments can resist exposure to bleach and are durable enough to resist multiple wash/dry cycles without loss of strength or shape change due to shrinkage. Figure 10 compares the tensile strength of Vectran HS vs. Aramid after exposure to various concentrations of bleach.

Figure 10: Tenacity Retention
Vectran HS vs Aramid

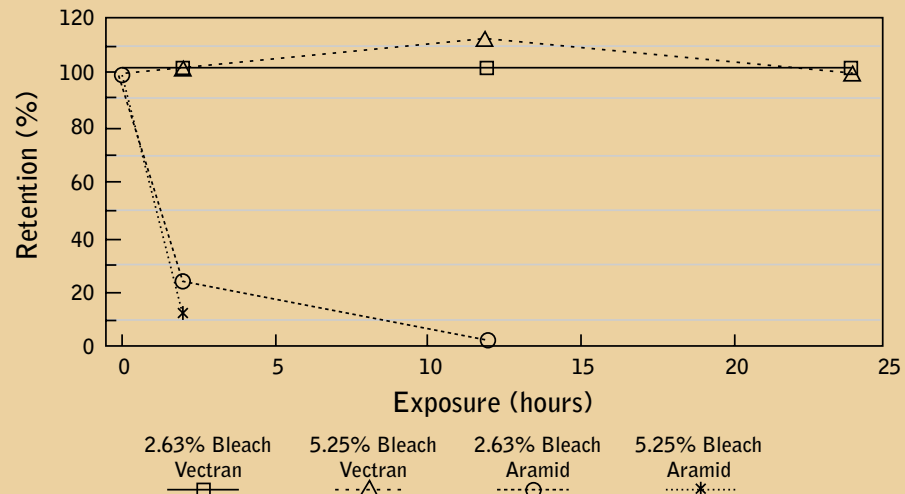

Creep

Creep:

Creep is the continued extension of a material when subjected to long-term loading. Resistance to creep is a critical component in material selection for many applications requiring long-term property retention (e.g. sailcloth, halyards, bowstring, marine cables, robotic tendons, etc.).

An important property for certain rope applications, creep was measured on Vectran fiber, braid, and wire-rope constructions. For fiber creep tests, the change in distance was measured between two defined points, initially 2.0 m apart, on a 1500 denier/300 filament thread-line hanging vertically under load. With no twist in the fiber, no creep was observed in samples loaded to 25 and 33% of breaking load after 569 days. With 1.0 turn/cm. in the fiber, no creep was observed in a sample loaded to 50% of breaking load after 115 days, at which time the test was terminated.

A major aerospace company conducted creep tests on Vectran braid. This company measured the change in distance between two defined points on a sample loaded to 37% of the rated breaking load of the braid. After initial construction adjustment, no creep growth was observed after 180 days.

A manufacturer of high performance ropes conducted a stress-relaxation test on a 1/2" Vectran wire-rope construction. The test sample was tensioned to a fixed load; tensions were recorded periodically from load cells at each end of the sample. As creep occurred, the load decreased, and the sample was subsequently re-tensioned back to the original load. Test results are compared with those for similar tests on aramid and UHMWPE wire-rope constructions in Figure 11. Creep was not observed on the Vectran rope. Lack of creep under simple loads up to 50% of breaking strength is one of the unique and most beneficial characteristics of Vectran fiber.

Figure 11: Vectran HS Wire Rope Creep

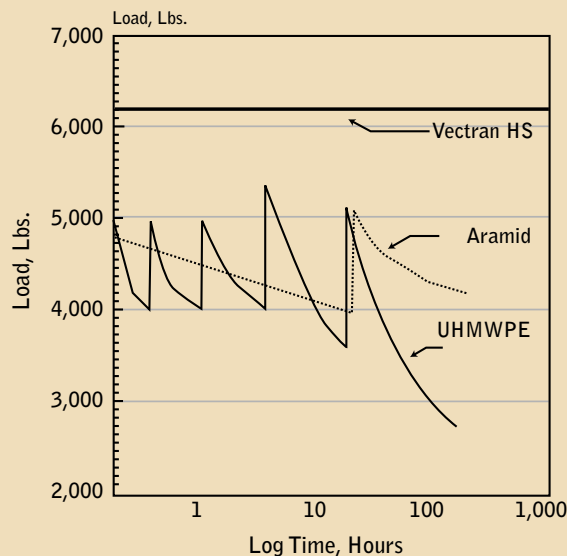

Abrasion Resistance

Abrasion Resistance:

Test procedures for determining abrasion resistance in the rope and cable industry reflect particular use requirements rather than adherence to a widely accepted industry standard. An independent rope and cordage industry test facility conducted abrasion tests on 1500 denier thread-lines to obtain a qualitative comparison of abrasion resistance between Vectran HS and Aramid. The test configuration is shown in Figure 12. Cycles-to-failure were recorded by using the test arrangement described by the testing facility. The higher the number of cycles-to-failure, the better was the abrasion resistance of the sample. Failure was defined as the threadline breaking. For wet testing, samples were soaked in water for one hour; the test was then conducted in a beaker of water with the crossover twist fully submerged. When a marine finish was applied to Vectran HS and aramid, Vectran HS showed significantly better results (Table 8) in both dry and wet tests.

Table 8:
Fiber Abrasion of Vectran HS

| | Cycles-to-failure* | |
|---------------|--------------------|----------|
| Test Load lbf | 1.10 lbf | 1.75 lbf |
| Dry Test | | |
| Vectran HS | 12987 | 3581 |
| Aramid | 939 | 422 |
| Wet Test | | |
| Vectran HS | 30519 | 16524 |
| Aramid | 3029 | 1719 |

*1500 denier threadline without twist. Wet data after one hour soak.
Marine finish applied to Vectran and Aramid

Figure 12: Yarn-On-Yarn Abrasion Test Set-Up

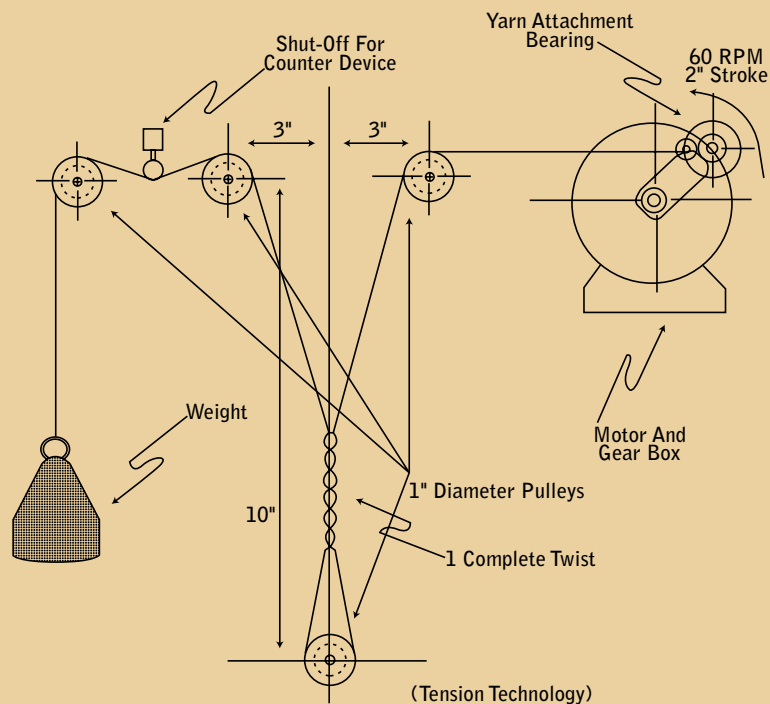

Abrasion Resistance

Samples of Vectran HS 1500/300 fiber with T-97 finish were evaluated on an eight position yarn-on-yarn tester versus a range of competitive yarns including Aramid A, Aramid B, Aramid C, Aramid D, and UHMWPE. Dry/wet testing included eight replicates. Results are shown in Tables 9 and 10 respectively. Samples tested contained no twist. Previous tests confirmed that twist level in fiber samples has a dramatic impact on abrasion resistance. In general, twist improved the abrasion resistance of Vectran and detracted from UHMWPE. Submersion in water offers some lubrication improvement for Vectran. UHMWPE showed greater improvements. The Aramid group of fibers all performed worse in water.

Table 9:
Comparative Testing of Yarn-on-Yarn Abrasion Resistance, Dry/No-Twist

| Yarn | Cycles-to-Failure | | %CV |
|-----------------------|-------------------|------|-----|
| | Average | SD | |
| 1500d Vectran HS T-97 | 16672 | 2418 | 15% |
| 1500d Aramid A | 1178 | 115 | 10% |
| 1420d Aramid B | 718 | 68 | 10% |
| 1500d Aramid C | 974 | 97 | 10% |
| 1500d Aramid D1 | 1510 | 55 | 4% |
| 1500d Aramid D2 | 1773 | 228 | 13% |
| 1600d UHMWPE | 8518 | 424 | 5% |

Table 10:
Comparative Testing of Yarn-on-Yarn Abrasion Resistance, Wet/No-Twist

| Yarn | Cycles-to-Failure | | %CV |
|-----------------------|-------------------|------|-----|
| | Average | SD | |
| 1500d Vectran HS T-97 | 21924 | 6292 | 29% |
| 1500d Aramid A | 705 | 202 | 29% |
| 1420d Aramid B | 258 | 34 | 13% |
| 1500d Aramid C | 486 | 143 | 29% |
| 1500d Aramid D1 | 990 | 145 | 15% |
| 1500d Aramid D2 | 758 | 187 | 25% |
| 1600d UHMWPE | 23619 | 6108 | 26% |

Abrasion test comparisons of Vectran and aramid braids were conducted by a high-performance rope and cable company using the test shown schematically in Figure 13. Without marine finish on the braid, Vectran outperformed aramid (Table 11). With marine finish applied to both Vectran and aramid braids, Vectran again showed superior abrasion resistance.

Figure 13: Rope Abrasion Test Set-Up

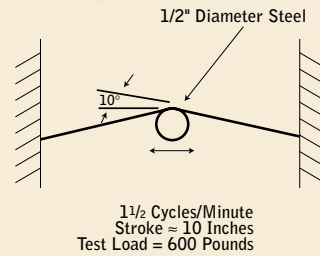

Table 11:
Braid Abrasion of Vectran HS*

| | Cycles-to-Failure | |
|----------------------------|-------------------|--------|
| | Vectran HS | Aramid |
| 600 lbf Load | | |
| Without marine finish | 286 | 83 |
| With marine finish applied | 1250 | 93 |

* Eight-strand plain braid
64X1670-dtex threadlines
All tests dry

Another high-performance rope and cable company conducted bend-over-sheave tests on a Vectran HS wire rope construction. Celanese standard finish was applied to Vectran HS fiber prior to rope manufacture. The rope performed well with increasing load (Figure 14). Good abrasion resistance in the presence of a lubricant, whether the lubricant is water or a more sophisticated finish, is an attribute of Vectran fiber.

Figure 14: Vectran HS Wire Rope
Bend-Over-Sheave

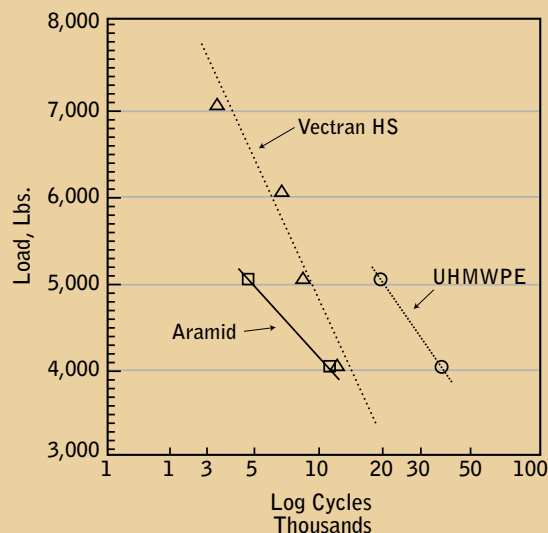

Compression/Flex Fatigue

Compression/Flex Fatigue:

The microfibril, is the fundamental building block in polymers made from flexible linear molecules. Microfibrils are observed in highly oriented, high modulus fibers such as the lyotropic aramids and the thermotropic liquid crystal polymers (Vectran). These fibers have in common a factor of ten, weaker compressive strength than tensile strength. Failure generally occurs by strain localization or energy absorption via formation of kink bands and by fibrillation. The molecular basis of kink band formation has been a subject of a number of studies. The highly oriented Vectran and aramid fibers have ordered microfibrils arranged parallel to the fiber axis. This orientation provides the excellent stiffness, or high modulus, as well as good tensile strength. Folding yarns or fabrics causes compressive strain resulting in local, microfibrillar misorientation, which appears as a kink band. Kink bands form in the three-dimensionally crystalline aramid fibers and in the liquid crystalline Vectran fibers. It seems apparent that the fibers do not need to be crystalline to form kink bands. Typically, the kink bands are at a local, high angle bending along the chain axis. The boundaries are well defined and can be observed in PLM (polarized light microscopy) as dark bands or stripes at about 45° to the fiber axis. The kink bands may be dislocations due to a buckling and breaking of the stiff polymer chains. High resolution imaging by transmission electron microscopy shows chain buckling. Scanning tunneling microscopy shows buckling as well as local microfibrils, about 10 nm in diameter, which appear to be broken. Once enough microfibrils are broken with the kink band, the entire fiber will fail.

Recent unpublished work, described here, addressed the specific failure mechanisms of aramid and Vectran fibers resulting from flexing or folding (Linda Sawyer / Ticona). In this study, individual yarns of Vectran HS, Aramid A and Aramid B were folded in a folding endurance tester (Tinius Olsen / M.I.T.) (Figure 15) for various numbers of cycles and to failure. Yarns were examined by (PLM) and scanning electron microscopy to assess the failure mechanism as a function of folding cycles. Folded yarns that had not failed were tested for tensile strength retention (Figure 16).

Figure 15: Folding Endurance Tester
(Tinius Olsen / M.I.T.)

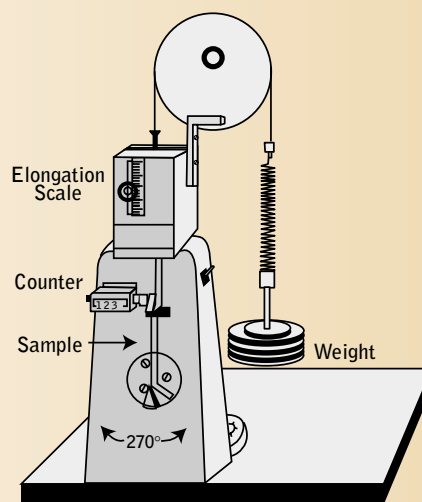

Flex/Fold Resistance
Cycles to Failure
400 Denier Filament Yarn

Figure 16: Tensile Strength vs Flexural Fatigue

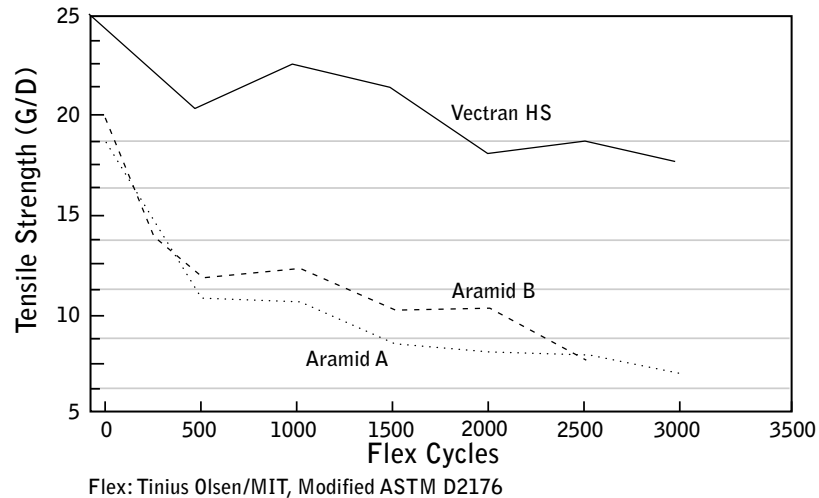

It is well known that the folding endurance of Vectran is significantly greater than that for aramids. Aramid yarns were flexed to failure, and also flexed to 50% tensile strength retention. At about 1,000 cycles, aramid yarns retain 50% of their initial tensile strength whereas Vectran HS retains ca. 93% of its tensile strength. Aramid has only 36% strength retention at 3,000 cycles whereas this level of strength retention is reached for Vectran at nearly five times that number of cycles, at 15,000 cycles. Yarns folded for 500, 1,000, 1,500, etc. cycles as well as after total failure, were examined by microscopy techniques to assess the failure mechanisms. It is interesting to note that although the compressive strength of the fibers are generally thought to be similar, the resistance to failure in the folding test and the mechanism of failure was very different. In the case of both aramid yarns, even 500 to 1,000 cycles resulted in major fibrillation of the individual fibers in the yarn. Fibers were split apart and the yarns appeared very "fuzzy". After breaking during testing, individual fibers appeared to have fibrils and microfibrils at the fiber ends. The Vectran fibers formed kink bands with the numbers of kink bands increasing with the number of flex cycles. After folding for thousands of cycles (>15,000 cycles) the Vectran fibers appeared to fail at the kink bands, most likely due to tensile failure. However, it is clear that the energy absorbed by kink band formation resulted in nearly five times the resistance to failure in flex folding. Therefore, the flex folding is a more severe limitation for aramid than for Vectran yarns.

An aerospace company using their proprietary coating system coated fabric candidates (Vectran and an aramid) in an identical manner. After coating, test specimens were cut in the warp direction for tensile testing. Specimens contained an equal number of warp yarns for its entire length. Test specimens measured one inch in width by 60 inches in length. Tensile testing was in accordance with FED-STD-191, Test Method 5102. Special tests simulated hard creasing and folding. The 1" X 60" test specimen described above was first folded in half upon itself. A 10 pound steel roller was then dragged over the creased area. The specimen was then folded back upon itself in the opposite direction and rolled again. This procedure defined a single cycle. Tensile strength measurements occurred after a predetermined number of cycles. After 100 flex cycles, the Vectran fabric lost 0.8% tensile strength while the aramid fabric lost 22.9% tensile strength. Breakage occurred at the crease with the aramid fabric but away from the crease with the Vectran fabric.

Compression/Flex Fatigue

Another aerospace company employed a "whipper" tester to conduct fatigue tests on Vectran braid samples 18 m long and 6.4 mm in diameter. Tension in the braid was 1000 lbf, and cycling was done at 10 Hz, with a 2.8 cm amplitude. Vectran braid strength was reduced 10% after one million cycles compared with a reduction of 30% for aramid braid. The Vectran braid exhibited no further reduction in strength up to five million cycles, the test limit.

Flex fatigue is a critical concern in sailcloth. Using a Tinius Olsen/M.I.T. folding endurance tester, the flex fatigue of 400 denier threadlines was compared. The fiber sample is loaded with a specified weight and oscillated through a 270° angle at a rate of 175 cycles/minute (ASTM D-2176). The results of three tests per fiber are in Table 12. Sailcloth manufacturers confirmed these tests.

Table 12:
Flex cycles-to-failure for 400 denier samples and 1.36 kg Load

| | M Cycles-to-Failure | |
|------------|---------------------|-----------|
| | Average | Range |
| Vectran HS | 18.1 | 16.5-19.8 |
| Aramid A | 1.3 | 0.7-1.6 |
| Aramid B | 2.2 | 1.3-3.6 |

Pin Diameter

Pin Diameter:

Celanese contracted aerospace and rope manufacturers to conduct pin diameter tests on Vectran braid and wire rope, respectively. The test configurations are shown in Figure 17.

Figure 17: Cord Test Sample Dimensions

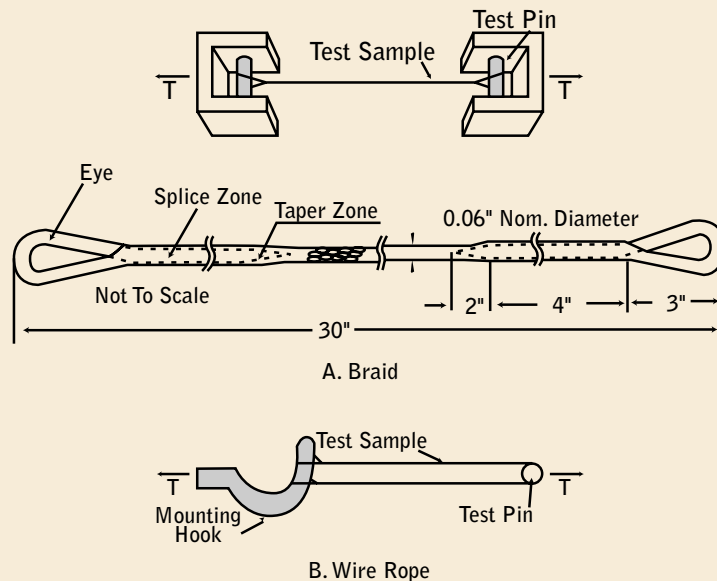

For the braid tests, each sample was 30 inches long and eye spliced on both ends with a long taper to minimize stress concentration where the splice begins. Each sample was tensioned three times to half its breaking strength to remove construction slippage before being tensioned to break. Pin diameters ranged from 0.110 inches to 0.31 inches. D/d (pin diameter/rope diameter) ranged from 1.5 down to 0.7 (A braid D/d ≥ 1.0 is recommended, see figure 23). For the larger wire rope tested, each sample was cycled five times 0-5,000 lbs., five times 0-10,000 lbs. and tensioned to break. The rope diameter was 0.5 inches; D/d ranged from 7.56 down to 2.28.

Vectran braids showed no decrease in break strength with decreasing D/d. Furthermore, breaks occurred in the middle of the sample and not at the pins. For the 0.5 inch diameter wire rope construction, Vectran had a higher break strength than aramid over the range of pin diameters tested (Figure 18). While no change in Vectran braid break strength was observed with decreasing pin diameter, a decrease was observed for the Vectran wire rope construction. The filaments in a braid construction are able to move easier. They share load better, reduce compression, and reduce tension differences between individual filaments.

Figure 18: Break Strength vs D/d Wire Rope Construction

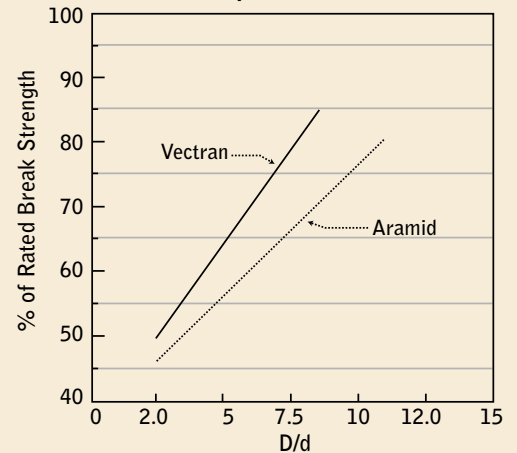

Vibration Damping / Impact Resistance

Vibration Damping / Impact Resistance:

Sports applications contain Vectran due to a combination of unique properties. Vectran does not absorb moisture, enhancing performance in composites. Dynatup impact tests were conducted on 1500 denier Vectran HS and aramid fabric samples. Both samples contained 13 X 13 plain weave constructions within Dow Derakane 411 resin (Vectran sample thickness: 0.0474 in.-0.0488 in., aramid sample thickness 0.040 in.). A 12.09 lb. load cell attached to a 5/8 in. tup dropped 36 inches through a metal tube before impact (Figure 19). Table 13 compares the impact energy required for sample penetration.

Figure 19: Dynatup Impact Test

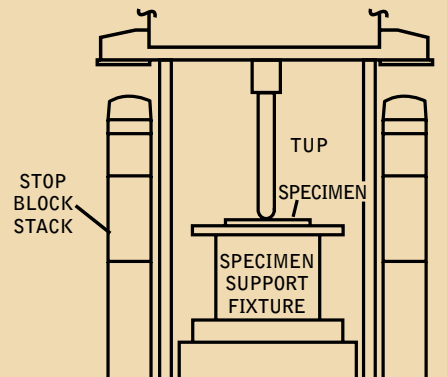

Table 13:

Impact Resistance Comparison of High-performance Fabrics

| Impact Energy (inch lbs.) | Vectran | Aramid |
|---------------------------|-------------|-------------|
| 25 | No | No |
| 30 | No | No |
| 50 | No | Penetration |
| 75 | No | Penetration |
| 100 | No | Penetration |
| 125 | Penetration | Penetration |

Vibration Damping

A vibration damping measurement system and a comparison of vibration damping characteristics for glass fiber, carbon fiber, aramid fiber, and Vectran fiber are found in Figures 20, 21. Table 14 lists performance characteristics of various metals and composite materials used by a manufacturer of audio components. The differences are apparent and demonstrate that Vectran fiber is ideal for vibration damping in sporting goods and audio applications.

Figure 20: Measurement System for Vibration Damping

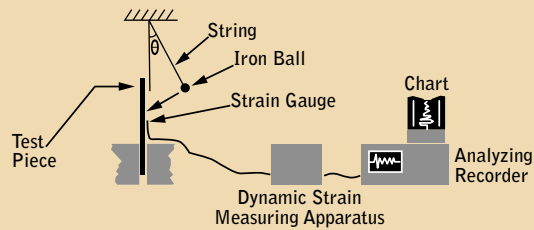

Figure 21: Vibration Damping

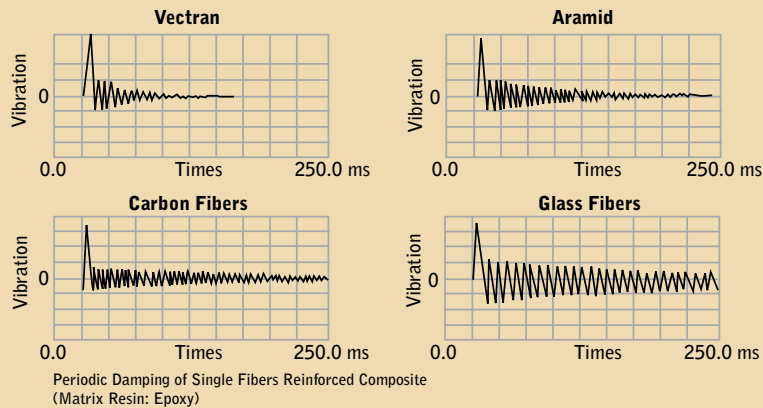

Table 14:

Audio Engineering Data For Various Metals and Composites

| Material | Speed of Sound m/s | Density g/cm ³ | Elastic Modulus Msi | Elastic Modulus Gpa | Modulus Rigidity E/p ³ | Internal Loss Tanδ | Elastic Modulus dynes/cm ² | Elastic Modulus N/m ² |
|-----------------|-----------------------|------------------------------|------------------------|------------------------|--------------------------------------|-----------------------|--|-------------------------------------|
| Beryllium | 12800 | 1.85 | 44.0 | 303 | 47.9 | 0.004 | 3.03E+12 | 3.03E+11 |
| Boron | 12899 | 2.62 | 63.2 | 436 | 24.2 | N/A | 4.36E+12 | 4.36E+11 |
| Carbon Fiber w* | 6902 | 1.42 | 9.8 | 68 | 23.6 | 0.035 | 6.76E+11 | 6.76E+10 |
| Paper (typical) | 1781 | 0.50 | 0.2 | 2 | 12.7 | 0.040 | 1.59E+10 | 1.59E+09 |
| Vectra (uni) | 4502 | 1.50 | 4.4 | 30 | 9.0 | 0.060 | 3.04E+11 | 3.04E+10 |
| Magnesium | 5000 | 1.74 | 6.3 | 44 | 8.3 | 0.004 | 4.35E+11 | 4.35E+10 |
| Aluminum | 5151 | 2.70 | 10.4 | 72 | 3.6 | 0.005 | 7.16E+11 | 7.16E+10 |
| Vectra (iso) | 2500 | 1.50 | 1.4 | 9 | 2.8 | 0.060 | 9.38E+10 | 9.38E+09 |
| Vectran w** | 4288 | 1.50 | 4.0 | 28 | 8.2 | 0.070 | 2.76E+11 | 2.76E+10 |
| Glass | 3216 | 2.00 | 3.0 | 21 | 2.6 | N/A | 2.07E+11 | 2.07E+10 |
| Polypropylene | 1200 | 0.91 | 0.2 | 1 | 1.7 | 0.090 | 1.31E+10 | 1.31E+09 |
| PET | 1802 | 1.38 | 0.7 | 4 | 1.7 | 0.010 | 4.48E+10 | 4.48E+09 |
| Polycarbonate | 1398 | 1.20 | 0.3 | 2 | 1.4 | N/A | 2.34E+10 | 2.34E+09 |
| Titanium | 4773 | 4.54 | 15.0 | 103 | 1.1 | 0.002 | 1.03E+12 | 1.03E+11 |
| Stainless Steel | 5125 | 7.90 | 30.1 | 207 | 0.4 | 0.002 | 2.07E+12 | 2.07E+11 |

*woven fabric within epoxy resin

**woven Vectran HS and M blend within epoxy resin

Cut Resistance

Cut Resistance:

The cut resistance of Vectran became very apparent during the first days of making the fiber. Cut resistance tests are many and varied. Uniformity of test sample and cutting edge is critical in any cut resistance test. Celanese uses a Sintech tensile testing machine modified as shown in Figure 22 to accept a fixture holding a knitted hoseleg sample.

Figure 22: Sintech Tensile Testing Machine

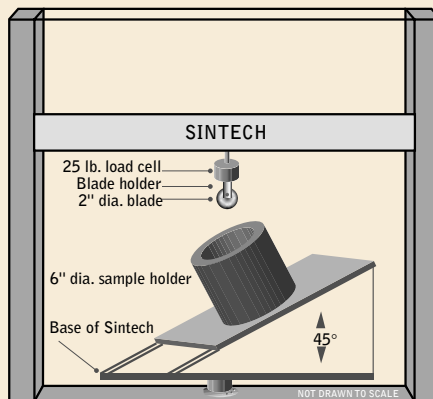

Tension is adjusted in hoseleg samples to allow a specified deflection at a given load. Inspection of the round blade to assure a clean cutting edge is critical. Table 15 compares the cut resistance of various fibers.

Table 15:
Sintech Cut Resistance

| Material | Denier | Relative Load |
|-----------|--------|---------------|
| Vectan HS | 1500 | 3.4 |
| Vectran M | 1500 | 2.2 |
| Aramid | 1500 | 1.1 |
| UHMWPE | 1500 | 1.0 |

Twist

Twist:

Twisting is the process of combining filaments into yarn by twisting them together or combining two or more parallel singles yarns (spun or filament) into plied yarns or cords. Twisting increases strength, smoothness, and uniformity. Twisting plied yarns or cords forms cables. The number of twists per inch of cord or cable is often called picks per inch (PPI).

Twist

High-performance fibers may or may not benefit from twisting. Table 16 reveals that Vectran tensile strength increases depending upon twist and denier. The data in table 16 suggest that the ideal twist level of 400 denier and 1500 denier Vectran HS is 2.5 TPI and 1.5 TPI respectively. Similar tests determine ideal cord and cable pick levels (Figures 23, 24, 25).

Table 16:
Vectran HS Tenacity vs. Twists per Inch (TPI)

| TPI | 400 denier tenacity gpd | 1500 denier tenacity gpd |
|-----|-------------------------|--------------------------|
| 0 | 25.6 | 25.6 |
| 0.5 | 26.5 | 26.7 |
| 1.0 | 27.8 | 27.6 |
| 1.5 | 27.8 | 28.6 |
| 2.0 | 28.6 | 27.9 |
| 2.5 | 28.8 | 27.6 |
| 3.0 | 28.1 | 25.8 |
| 3.5 | 28.3 | 24.0 |
| 4.0 | 28.3 | 21.8 |
| 4.5 | 27.8 | N/A |
| 5.0 | 27.8 | N/A |

Figure 23: Breaking Strength vs Pin/Cord Dia.
Ratio 8x1500/1 Construction

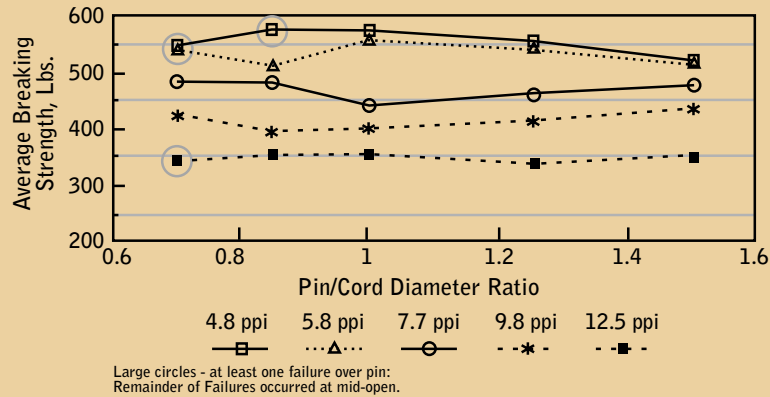

Figure 24: Breaking Strength vs Picks/Inch
Ratio 8x1500/1 Construction

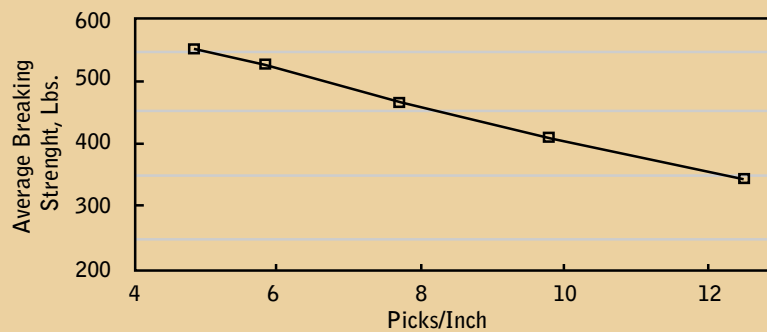
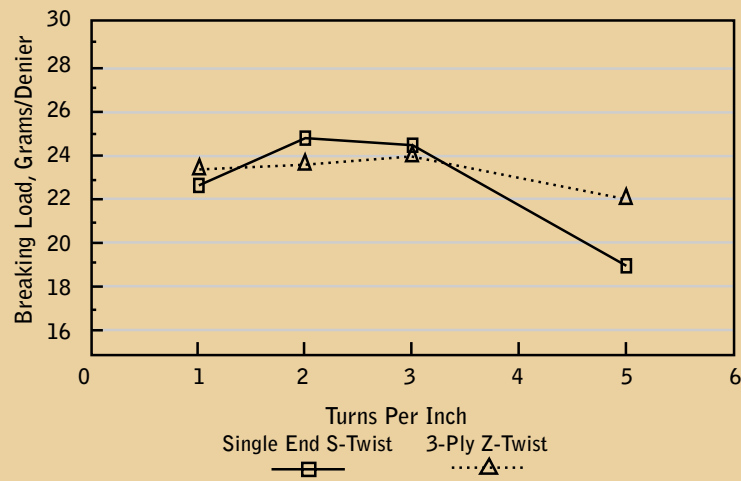

Figure 25: 1500/300 Vectran HS
Single End S-Twist And 3-Ply Z-Twist



UV Resistance

UV Resistance:

UV resistance is an issue with fabrics and ropes exposed to the elements. Many finishes, coatings, tafettas, and overbraids are available that ameliorate the effects of UV radiation. UV tests were conducted on a 0.6 cm diameter 12X1 braids of different fibers (Figure 26). Braiding a polyester jacket over a Vectran core helps reduce the strength loss due to UV (Figure 27). The outer fibers of the braided rope appear to protect the inside fibers from damage, explaining the leveling out of the tenacity curve.

Figure 26: Tenacity Retention

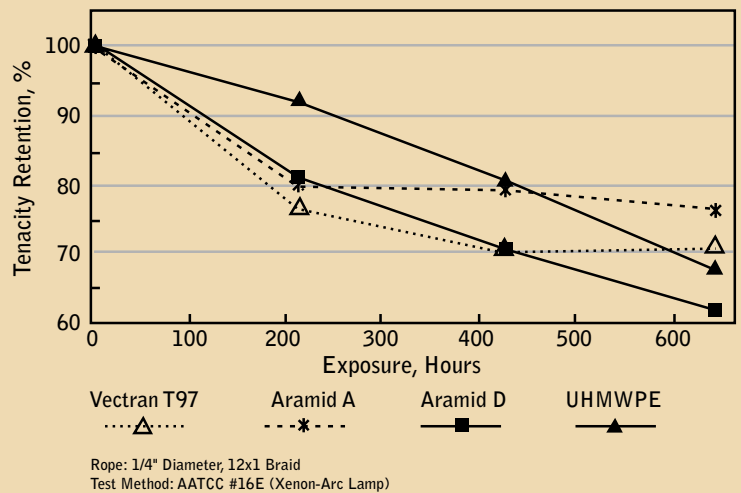
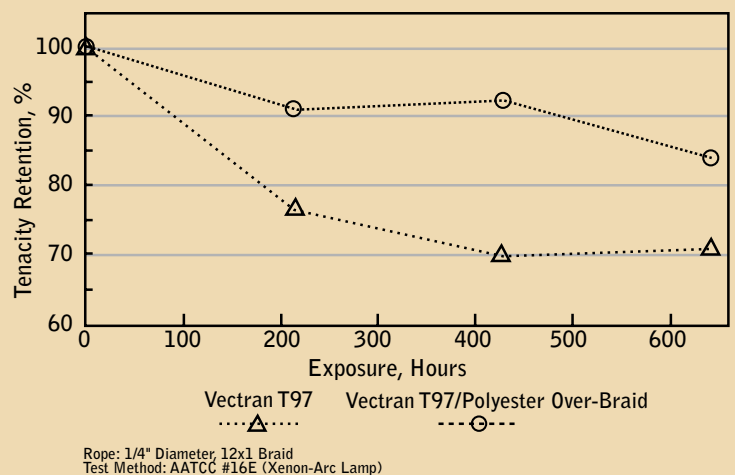

Figure 27: Tenacity Retention





To the best of our knowledge, the information contained herein is accurate. However, neither Celanese nor any of its affiliates assumes any liability whatsoever for the accuracy or completeness of the information contained herein. Final determination of suitability of any material and whether there is any infringement of patents is the sole responsibility of the user.

Users of any substance must satisfy themselves by independent investigation that the material can be used safely. We may have described certain hazards but we cannot guarantee that these are the only hazards which exist.

The Celanese name and logo are registered trademarks of Celanese Acetate LLC. Vectra and Vectran are registered trademarks of Celanese Acetate LLC.

The commodities are licensed by the United States for designated destinations. Diversion contrary to U.S. law is prohibited.

©1999 Celanese Acetate LLC. All rights reserved.

Celanese Acetate LLC
P.O. Box 32414
Charlotte, North Carolina 28232-9973
704.554.3148 Tel
704.554.3101 Fax